

# ORIGINAL KETTLE

ASSEMBLY GUIDE  
ENSEMBLE GUIDE  
MONTAGEANLEITUNG

E-4710  
E-5710



47 cm

57 cm



 BILT.

Read the owner's guide before using the barbecue.

Lisez le guide d'utilisation avant d'utiliser le barbecue.

Bitte lesen Sie das Benutzerhandbuch, bevor Sie den Grill verwenden.



**54738**

092418

enGB / da / de / es / fi / fr / it / nl / no / pl / pt / ru / sv

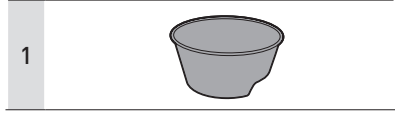
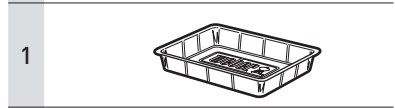
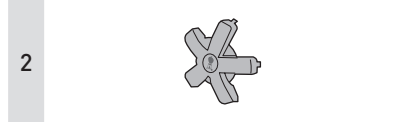
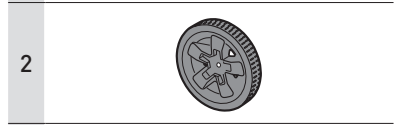
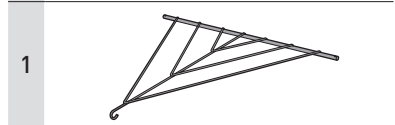
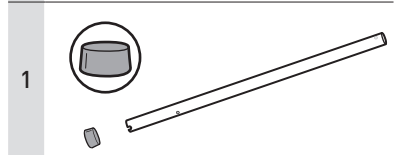
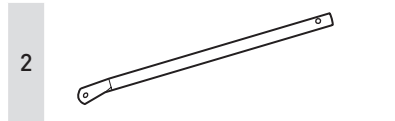
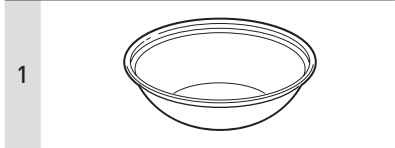
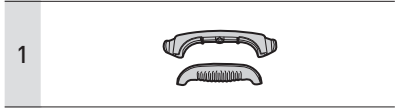
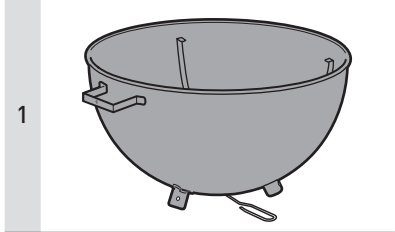
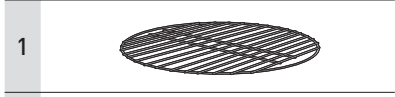
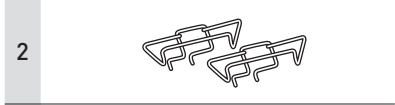
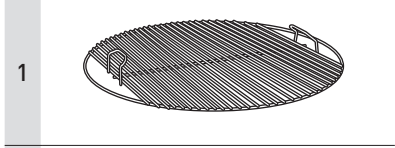
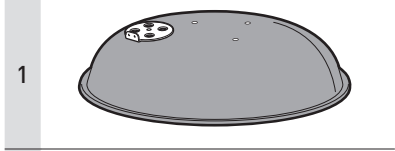
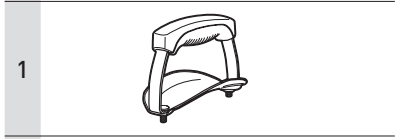

**EN** TOOLS INCLUDED:

**DA** MEDFØLGENDE VÆRKTØJER:

**DE** ENTHALTENE WERKZEUGE:

**ES** HERRAMIENTAS INCLUIDAS:

**FI** SISÄLTÄVÄT TYÖKALUT:

**FR** OUTILS INCLUS :

**IT** ATTREZZI INCLUSI:

**NL** INBEGREPEN

GEREEDSCHAPPEN:

**NO** VERKTØY INKLUDERT:

**PL** DOŁĄCZONE NARZĘDZIA:

**PT** FERRAMENTAS INCLUÍDAS:

**RU** ИНСТРУМЕНТЫ ВКЛЮЧЕНЫ:

**SV** VERKTYG SOM MEDFÖLJER:



**EN** TOOLS REQUIRED:

**DA** VÆRKTØJ PÅKRÆVET:

**DE** ERFORDERLICHES WERKZEUG:

**ES** HERRAMIENTAS NECESARIAS:

**FI** TARVITTAVAT TYÖKALUT:

**FR** OUTILS NÉCESSAIRES:

**IT** ATTREZZI NECESSARI:

**NL** BENODIGD GEREEDSCHAP:

**NO** NØDVENDIG VERKTØY:

**PL** WYMAGANE NARZĘDZIA:

**PT** FERRAMENTAS NECESSÁRIAS:

**RU** НЕОБХОДИМЫЕ  
ИНСТРУМЕНТЫ:

**SV** NÖDVÄNDIGA VERKTYG:

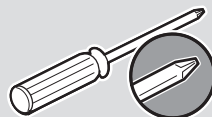

2



2

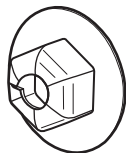

3

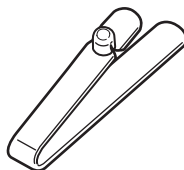

3



**EN** Download the free BILT app for 3D step-by-step instructions.

**DA** Download den gratis BILT-app med trin-for-trin-vejledning i 3D.

**DE** Lade die kostenlose BILT-App herunter, um dir eine Schritt-für-Schritt-Anleitung in 3D anzeigen zu lassen.

**ES** Descargue gratis la app BILT para recibir instrucciones paso a paso en 3D.

**FI** Lataa 3D-ohjeet sisältävä ilmainen BILT-sovellus.

**FR** Téléchargez l'appli gratuite BILT qui vous expliquera le montage étape par étape en 3D.

**IT** Per istruzioni 3D dettagliate, scaricare l'app gratuita BILT.

**NL** Download de gratis BILT-app voor stapsgewijze 3D-instructies.

**NO** Last ned BILT-appen gratis for trinvisse veiledninger i 3D.

**PL** Pobierz bezpłatną aplikację BILT z instrukcjami 3D krok po kroku.

**PT** Faça o download da aplicação BILT gratuita para obter instruções 3D passo a passo.

**RU** Загрузите бесплатное приложение BILT для получения пошаговой 3D-инструкции.

**SV** Ladda ned den kostnadsfria BILT-appen för steg-för-steg-instruktioner i 3D.

2

3-

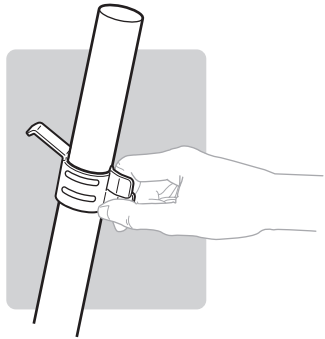
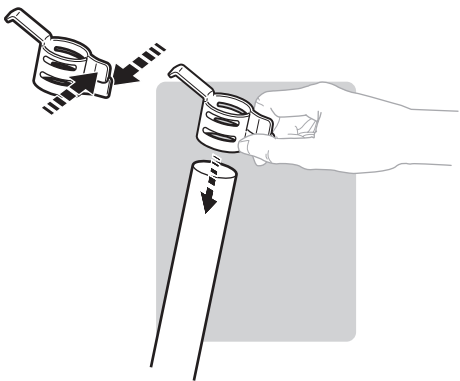
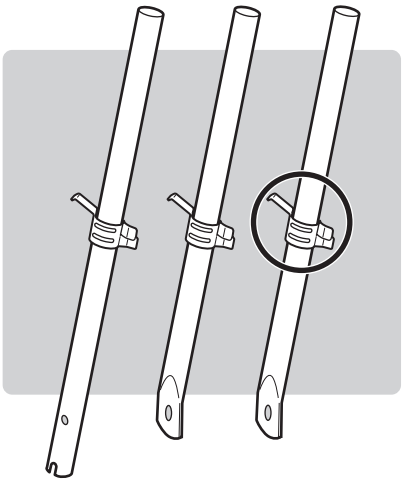

3

1-

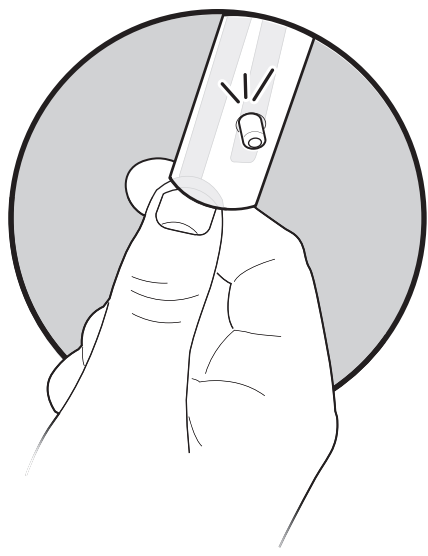
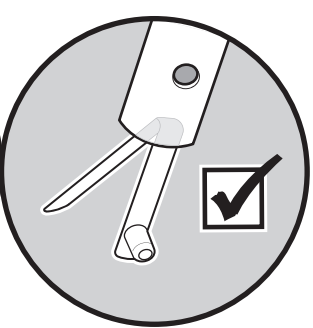
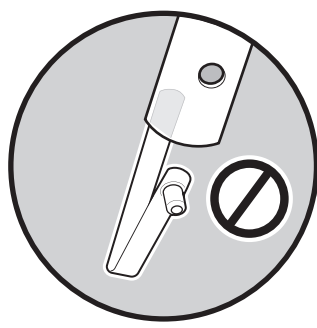
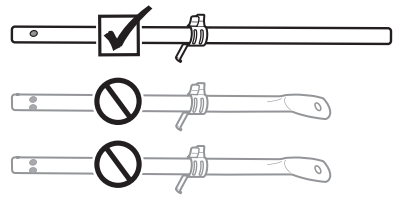
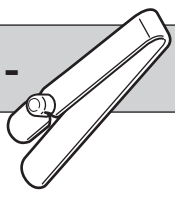

4

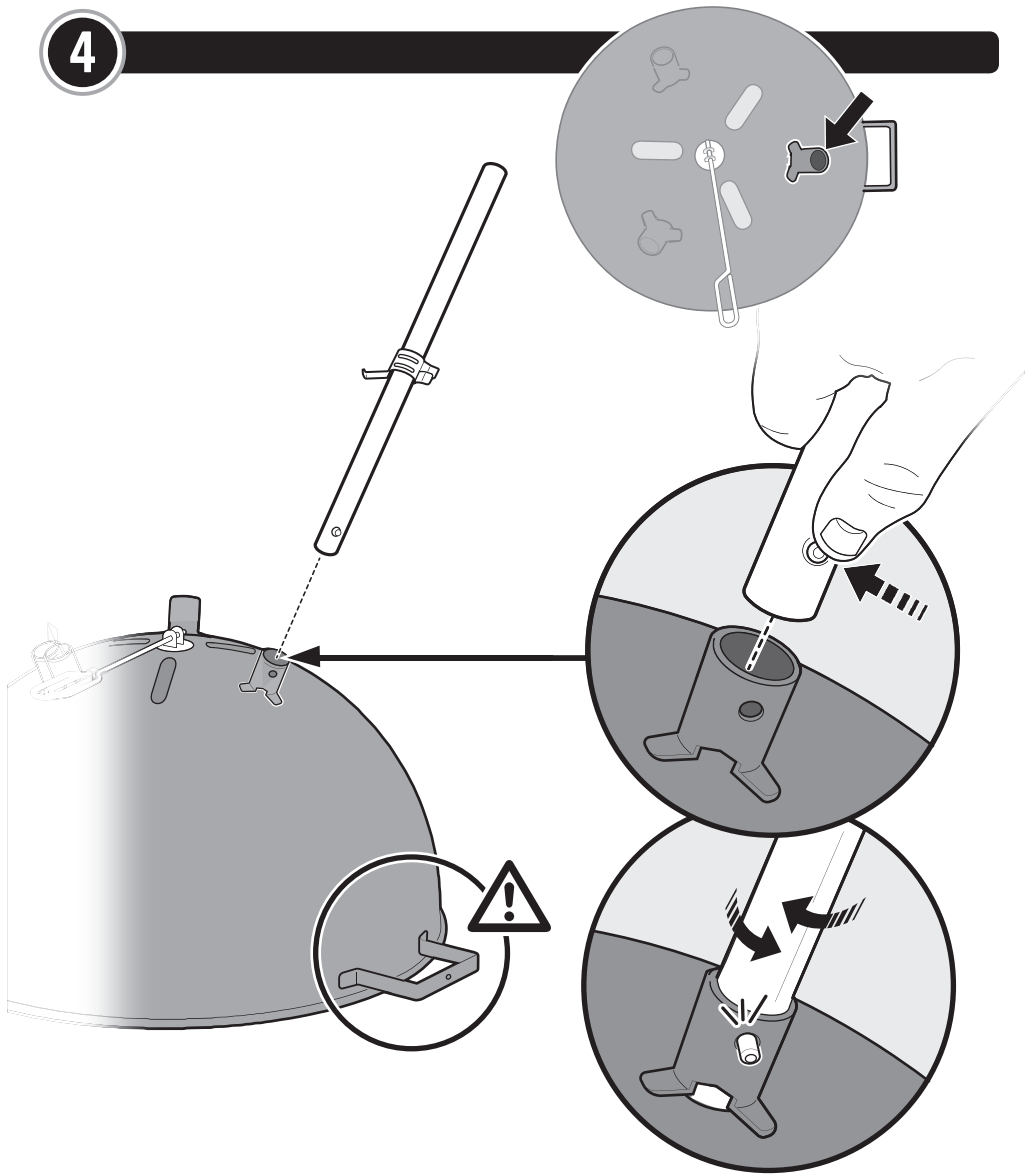

5

1-

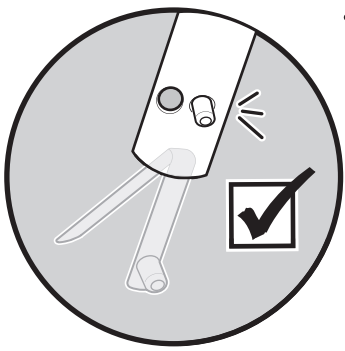
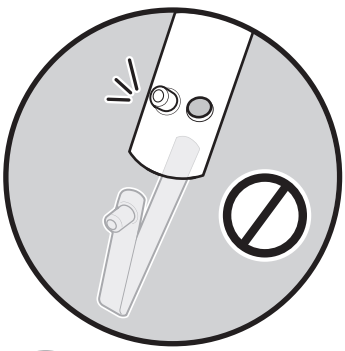
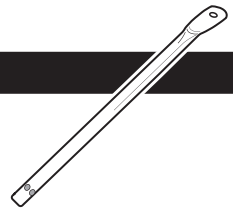
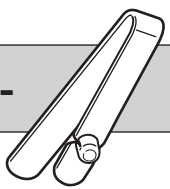

6

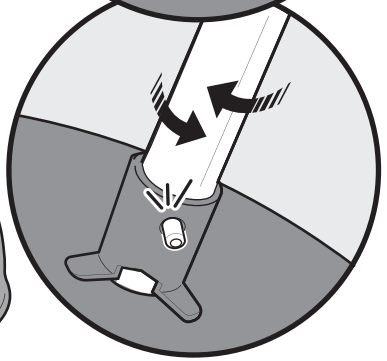
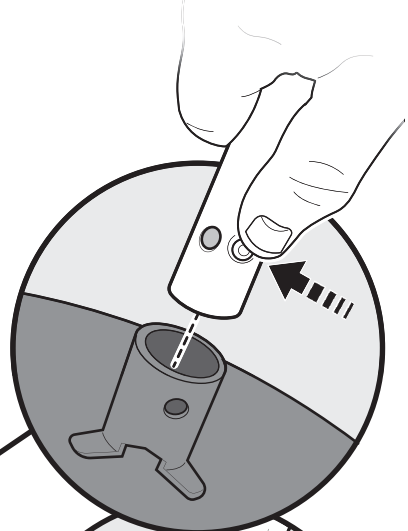
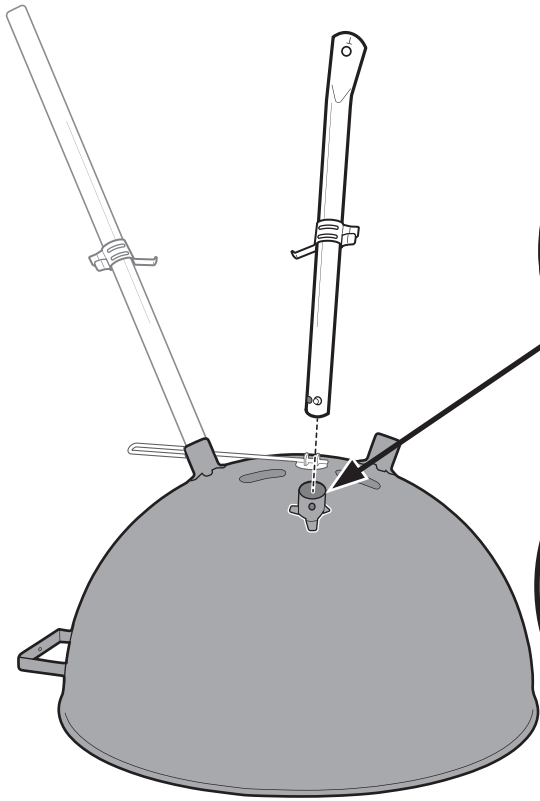

7

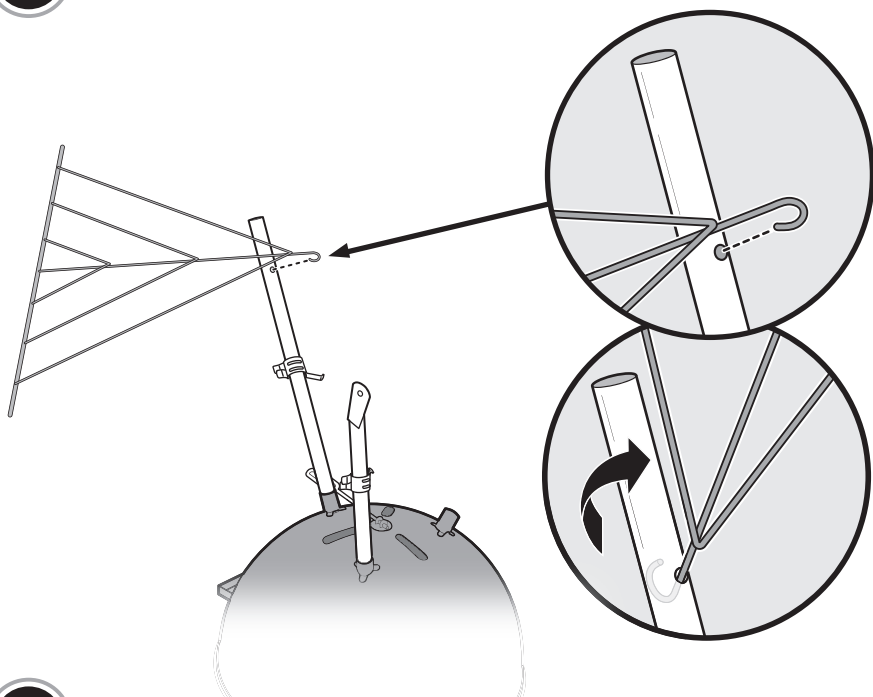

8

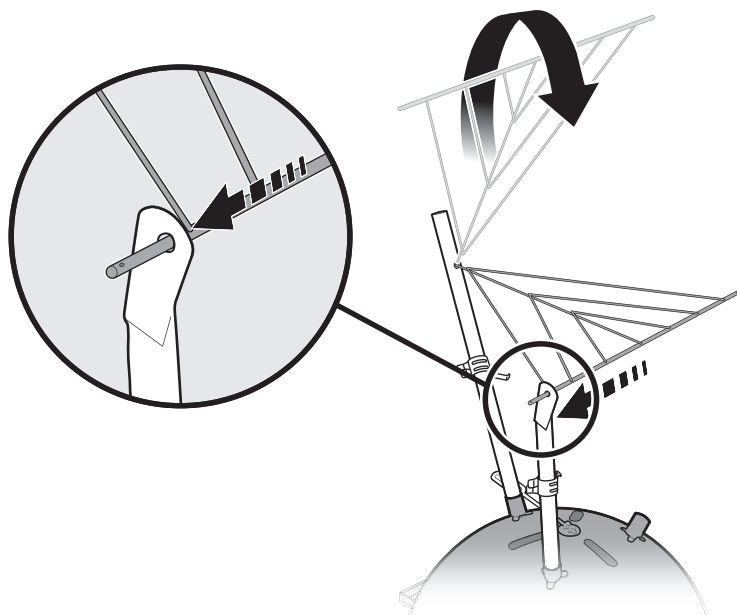



9

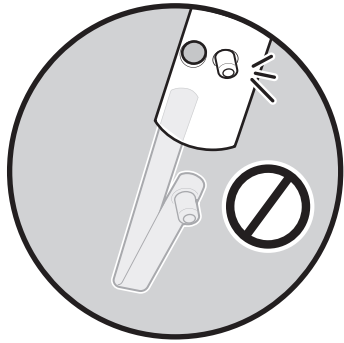
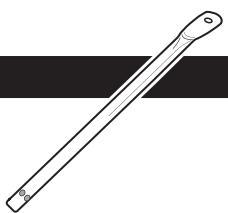
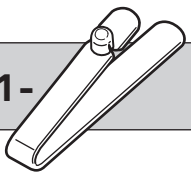

1-

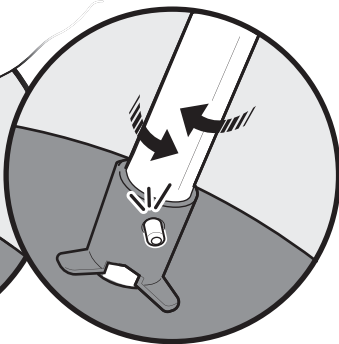
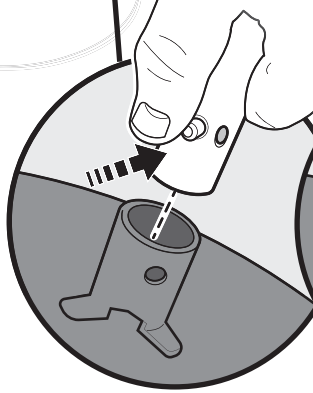
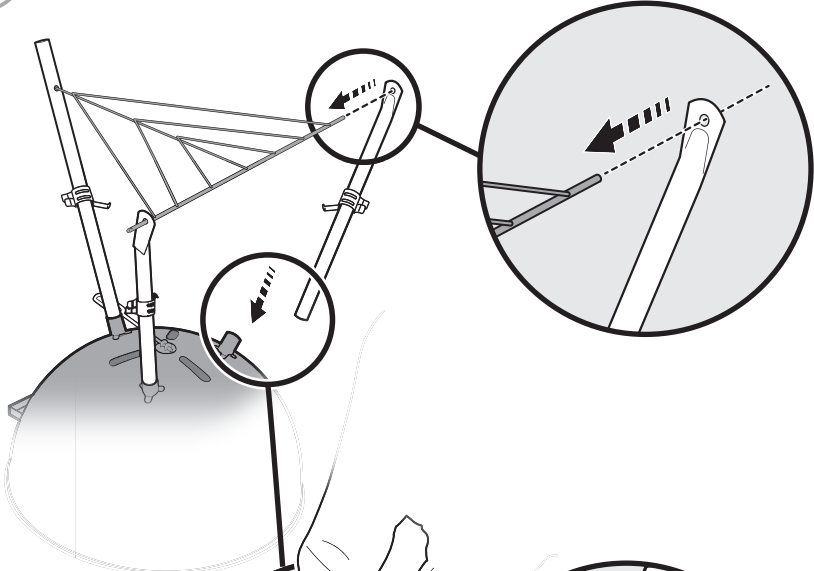

10



11

2-  2- 

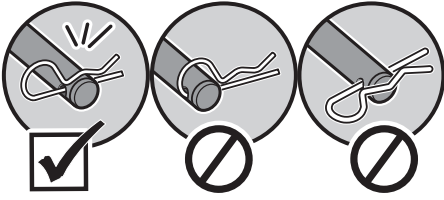
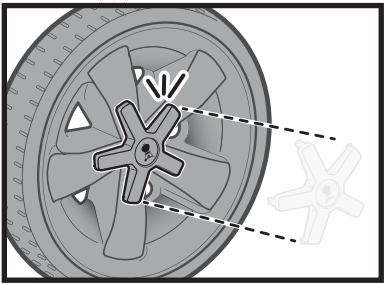
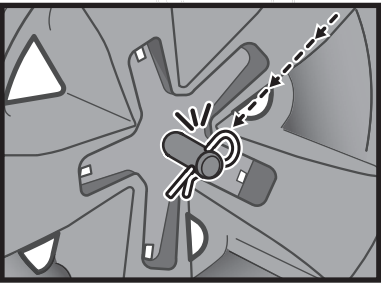
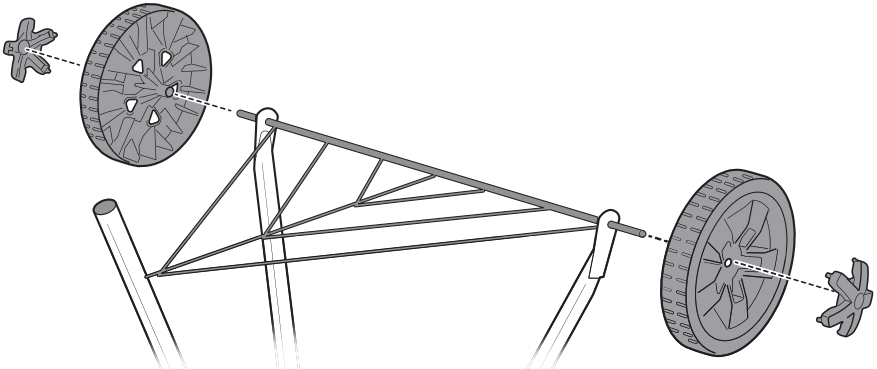

12

1- 

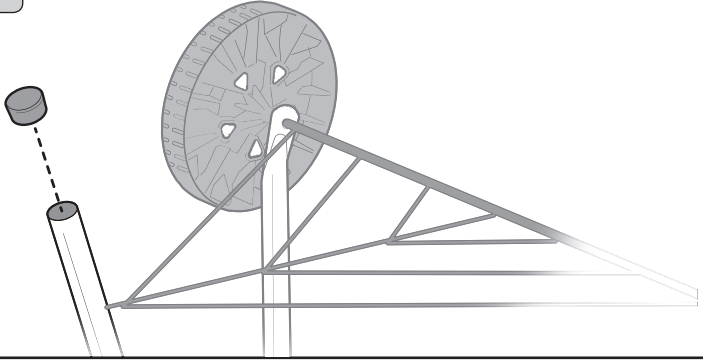

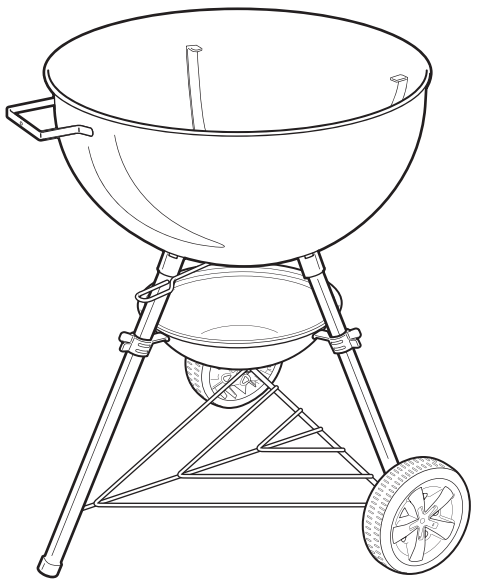
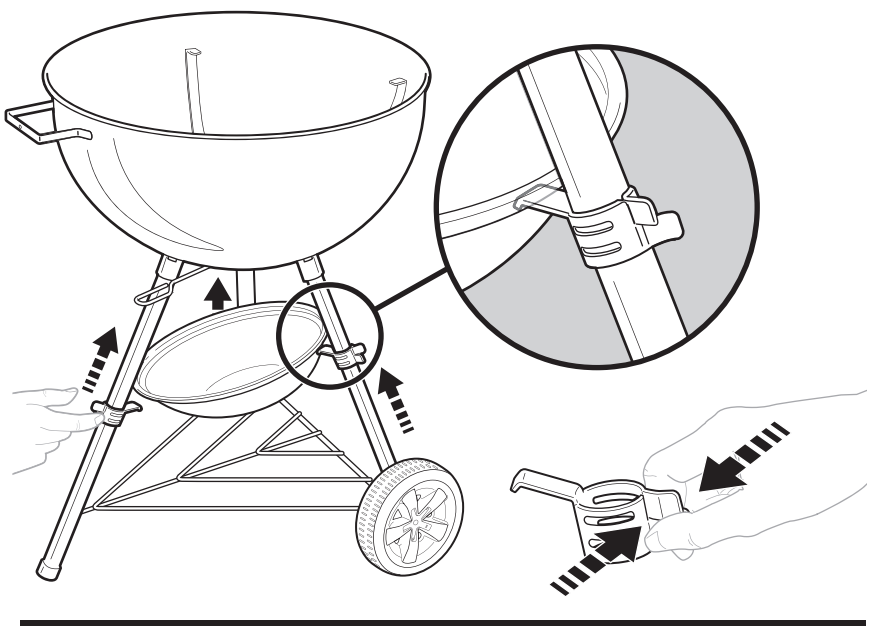

14

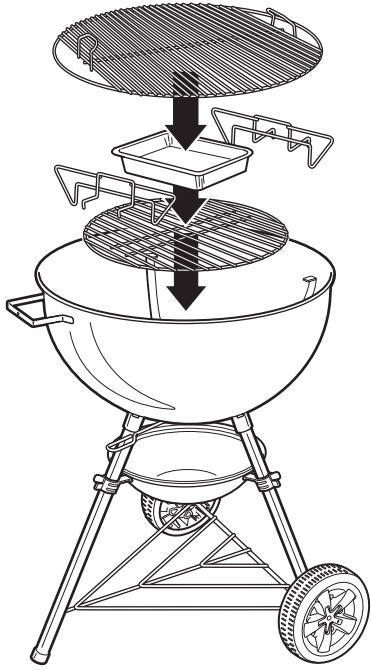

15

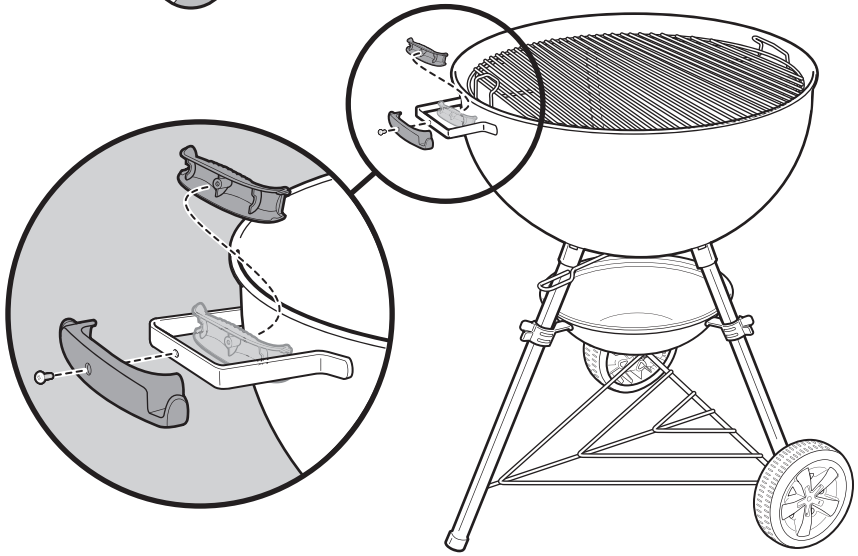

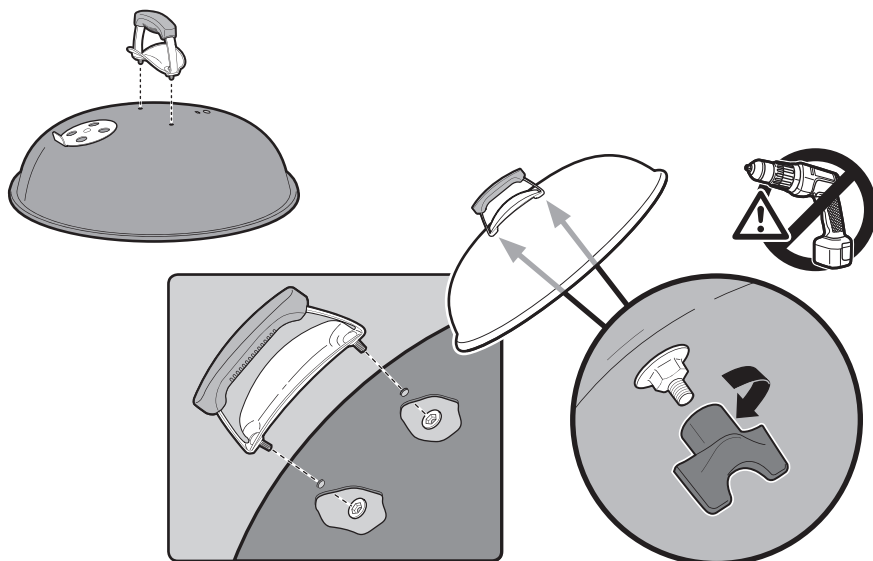

**EN** Tighten hardware until it is secure.

⚠ **DO NOT OVERTIGHTEN HARDWARE.**

**DA** Spænd godt til.

⚠ **UNDLAD AT SPÆNDE FOR HÅRDT.**

**DE** Befestigungsteile sicher festziehen.

⚠ **BEFESTIGUNGSTEILE NICHT ZU FEST ANZIEHEN.**

**ES** Apriete los herrajes hasta que estén bien sujetos.

⚠ **NO APRIETE EXCESIVAMENTE LOS HERRAJES.**

**FI** Kiristä kiinnikkeet kunnolla.

⚠ **ÄLÄ KIRISTÄ KIINNIKKEITÄ LIIKAA.**

**FR** Serrer fermement les vis.

⚠ **NE PAS TROP SERRER LES VIS.**

**IT** Stringere la minuteria fino a quando non è ben serrata.

⚠ **NON STRINGERE ECCESSIVAMENTE LA MINUTERIA.**

**NL** Bevestig de hardware totdat deze goed vast zit.

⚠ **NOOIT HARDWARE TE VAST BEVESTIGEN.**

**NO** Stram utstyret til det er sikret.

⚠ **IKKE STRAM UTSTYRET FOR HARDT.**

**PL** Dokreć do oporu elementy mocujące.

⚠ **NIE DOKRĘCAJ ZBYT MOCNO ELEMENTÓW MOCUJĄCYCH.**

**PT** Aperte as ferragens até estarem bem seguras.

⚠ **NÃO APERTAR AS FERRAGENS DEMASIADO.**

**RU** Затяните оборудование, пока оно не будет плотно зафиксировано.

⚠ **НЕ ПЕРЕТЯГИВАЙТЕ ОБОРУДОВАНИЕ.**

**SV** Dra åt muttrar och beslag tills de sitter fast.

⚠ **DRA INTE ÅT MUTTRAR OCH BESLAG FÖR HÅRT.**

17

1-

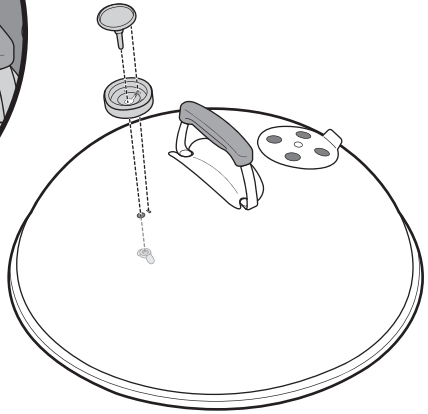
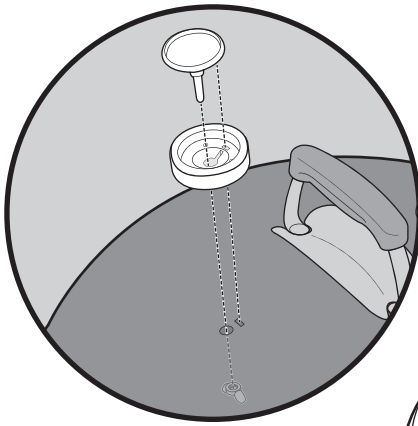

18

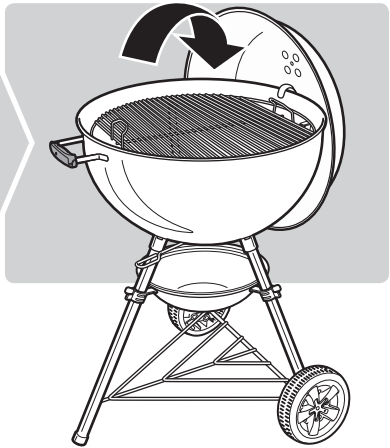
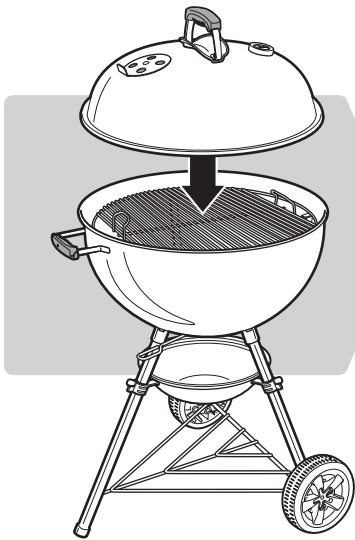

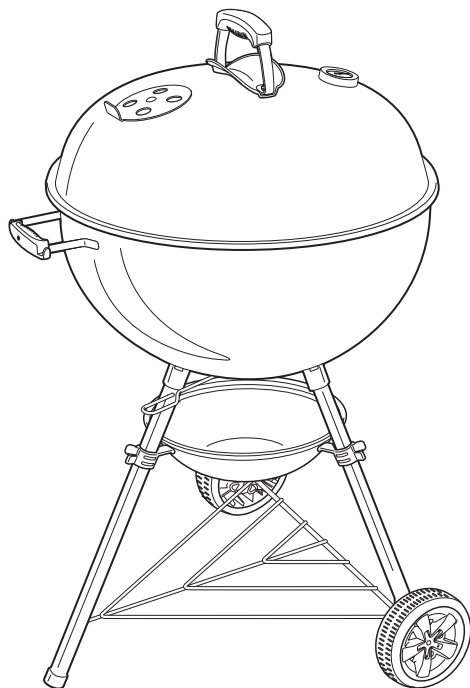

**EN** Make sure that all parts are assembled and hardware is fully tightened before operating the barbecue.

**DA** Sørg for, at alle dele er monteret og tilspændt korrekt, inden grillen tages i brug.

**DE** Vergewissere dich, dass alle Teile ordnungsgemäß montiert und alle Befestigungselemente fest angezogen sind, bevor du den Grill öffnest.

**ES** Compruebe el correcto montaje de todas las piezas y apriete bien los herrajes antes de usar la barbacoa.

**FI** Varmista ennen grillin käyttöä, että kaikki osat on koottu oikein ja kiinnikkeet on kiristetty.

**FR** Assurez-vous que toutes les pièces ont été utilisées et que les vis sont bien serrées avant d'allumer le barbecue.

**IT** Prima di utilizzare il barbecue, assicurarsi che tutte le parti siano assemblate e che la minuteria sia completamente serrata.

**NL** Zorg ervoor dat alle onderdelen zijn gemonteerd en volledig zijn vastgedraaid voordat u de barbecue gebruikt.

**NO** Sørg for at alle deler er monteret og at de er godt festet før du bruker grillen.

**PL** Przed przystąpieniem do korzystania z grilla upewnij się, że wszystkie części zostały zamontowane i że wszystkie śruby są mocno dokręcone.

**PT** Antes de usar o grelhador, certifique-se de que todas as peças estão montadas e as ferragens bem apertadas.

**RU** Перед началом эксплуатации гриля необходимо убедиться в том, что все компоненты собраны, а оборудование надежно зафиксировано.

**SV** Kontrollera att alla delar är monterade och att muttrarna är helt åtdragna innan grillen används.



WEBER-STEPHEN PRODUCTS LLC  
[www.weber.com](http://www.weber.com)

© 2018 Designed and engineered by Weber-Stephen Products LLC,  
1415 S. Roselle Road, Palatine, Illinois 60067 USA.